

ETİ MADEN İŞLETMELERİ GENEL MÜDÜRLÜĞÜ
KIRKA BOR İŞLETME MÜDÜRLÜĞÜ

YÜRÜRLÜK TARİHİ : 15.11.2013

REVİZYON NO : 00

AMBAR STOK NO :

SAYFA NO : 1

LAMİNELİ POLİPROPİLEN BAFFLE TORBA NORMAL SAPLI ALTTAN BOŞALTMALI

BOYUTU 1050 X 1050 X 1200 mm

AĞIRLIĞI : 1200 KGS

BASKI RENGİ : PANTONE 661 PC

SAP VE KOLON RENGİ : PANTONE 661 PC

ÖN, ARKA VE YAN YÜZ GÖRÜNÜŞÜ

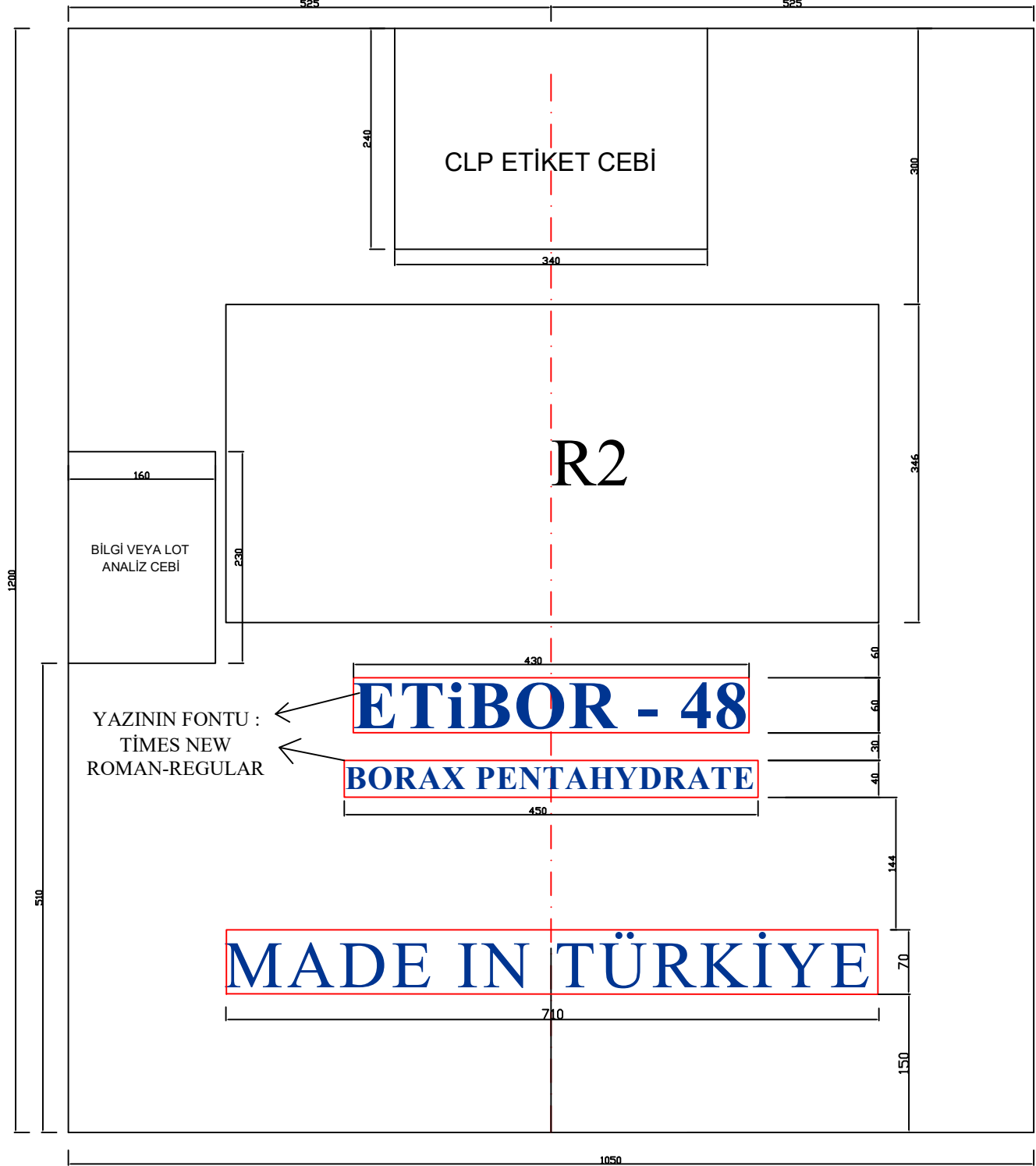

ÇİZEN VE HAZIRLAYAN
NEŞET CAN
AMBALAJ MALZEMESİ SORUMLUSU

ONAY
CÜNEYT AKSAK
STOK VE SEVKİYAT
BİRİM SORUMLUSU

PERSPEKTİF GÖRÜNÜŞ

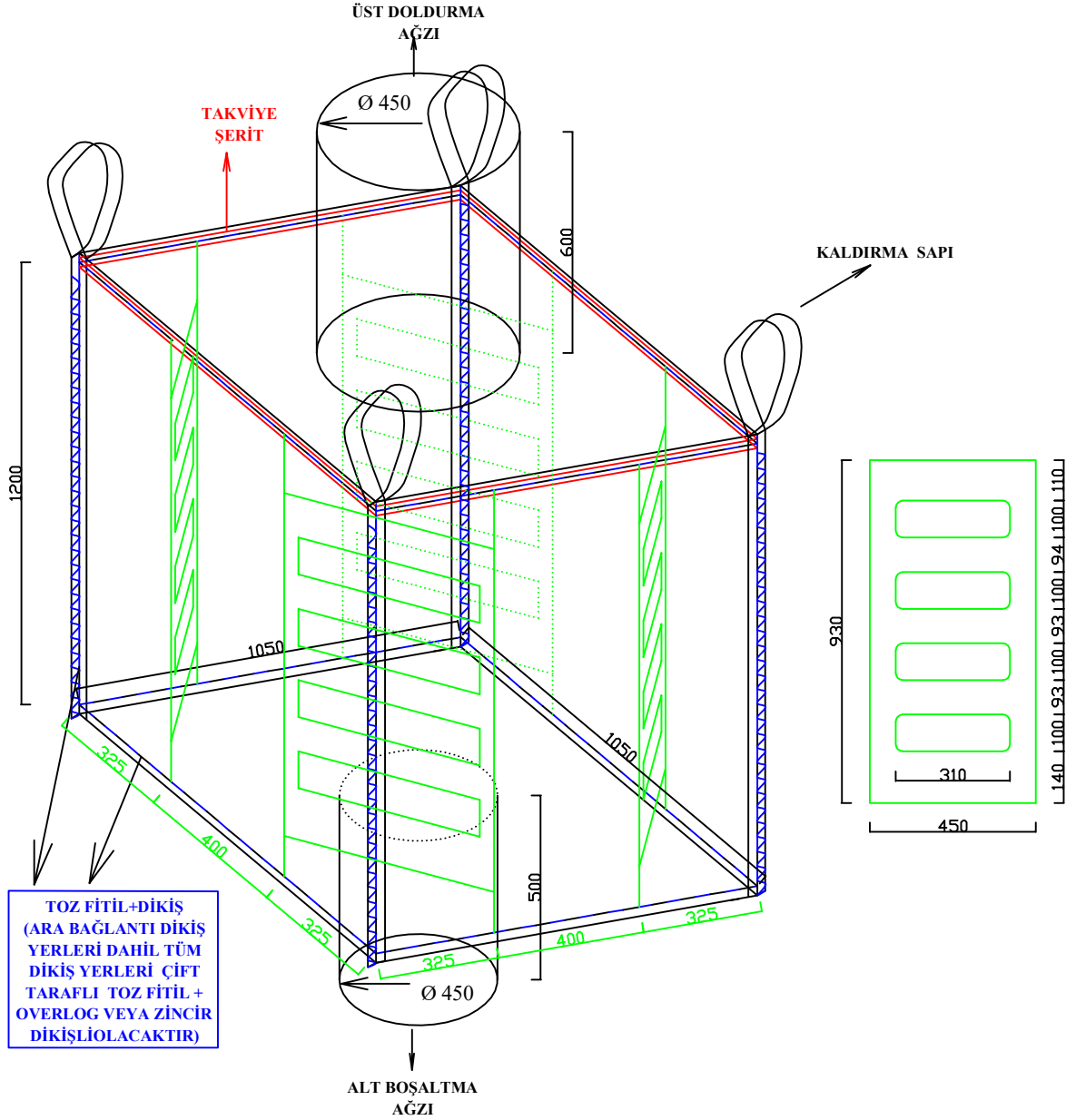

NOT :TEKNİK RESİM VE EKLERİNDEKİ TÜM ÖLÇÜLER mm'DİR

ÇİZEN VE HAZIRLAYAN
NEŞET CAN
AMBALAJ MALZEMESİ SORUMLUSU

ONAY
CÜNEYT AKSAK
STOK VE SEVKİYAT
BİRİM SORUMLUSU

ÜST DOLDURMA BACASI

PERSPEKTİF GÖRÜNÜŞ

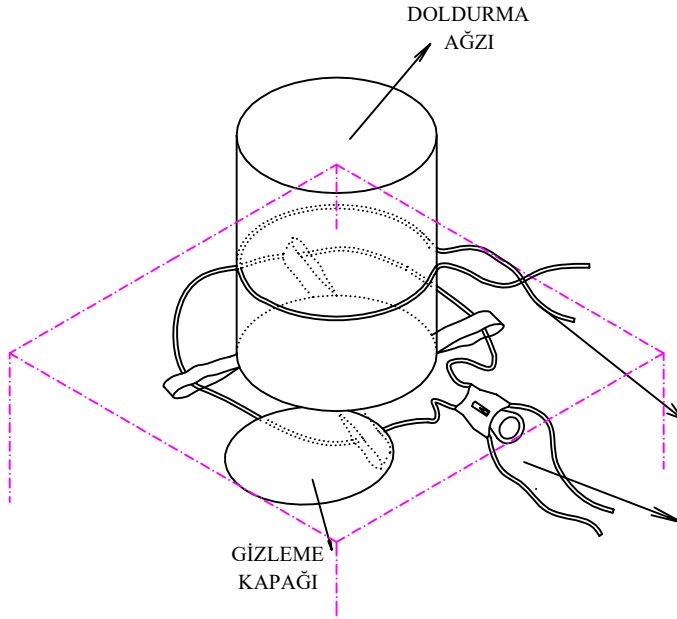

ÜSTTEN GÖRÜNÜŞ

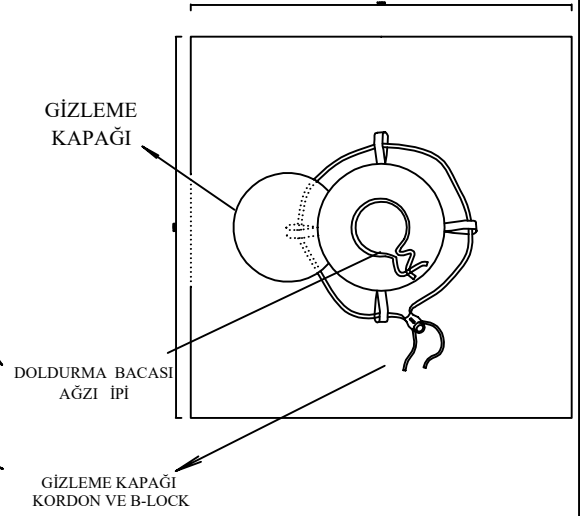

ALT BOŞALTIMA BACASI

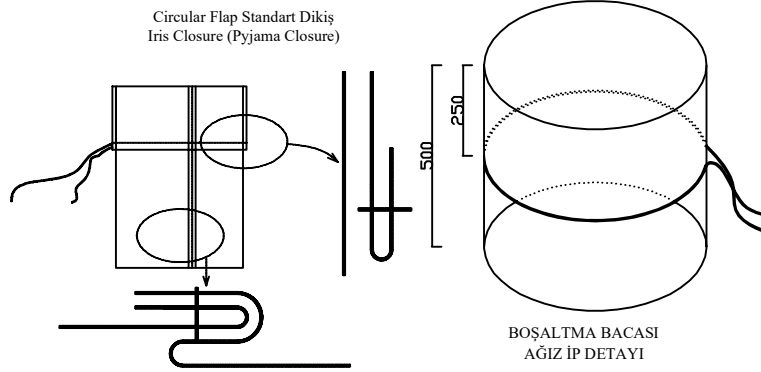

B-LOCK

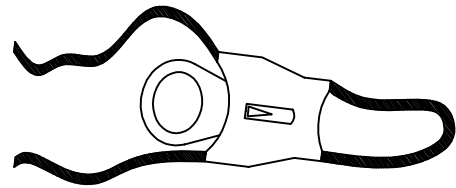
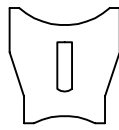
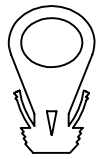

ÇİZEN VE HAZIRLAYAN
NEŞET CAN
AMBALAJ MALZEMESİ SORUMLUSU

ONAY
CÜNEYT AKSAK
STOK VE SEVKİYAT
BİRİM SORUMLUSU